

# RAYWIN



ISTRUCTION  
MANUAL

 **Comunello®**

# CONTENTS OF MANUAL

1.	General Information	page 3
1.1	Introduction to this manual	page 3
2	Safety	page 3
3.	Technical Data	page 5
3.1	Table of technical data and CE mark	page 5
4	Actuator	page 6
4.1	Types of power supply	page 6
4.2	Calculation of the force necessary	page 6
4.3	Pack and tools required for assembling the actuator	page 6
5	Installation	page 7
5.1	Installation sequence	page 7
5.2	Electrical connection	page 13
5.3	Operating test	page 14
6	Maintenance, Emergency Action & Cleaning	page 15
7	Protection Of The Environment	page 15
8	FAQ (frequently asked questions)	page 16
9	Guarantee	page 17
10	"CE" Declaration Of Conformity	page 18

# 1. GENERAL INFORMATION

## 1.1 Introduction to this manual

Please read carefully and follow the instructions detailed in this manual. Keep the manual for use and future maintenance. Pay attention to the configuration of the DIP-switches, to the data concerning the performance (see "Technical Data") and to the installation instructions. Improper use or incorrect operation, fitting or assembly can damage the system as well as cause injury to people and damage to property.

The assembling instructions are available on the official web site

<http://www.comunello.com/mowin>

# 2. SAFETY

This installation manual is written exclusively for competent professional personnel.

The installation, electrical connections and adjustments must be carried out conforming to good practice and according to the regulations in force.

Incorrect installation can cause a potential hazard.

The packing materials (plastic, polystyrene, etc.) must not be allowed to pollute the environment, but must be disposed of correctly, and must not be left within the reach of children since they can cause possible hazards.

Before starting installation, check the product is complete and undamaged.

If the power cable is damaged, it must be replaced by the manufacturer or his technical support or a similarly qualified person in order to avoid any risks.

Do not install the product in an explosive environment or atmosphere: the presence of flammable gas or fumes is a serious health and safety hazard.

Before installing the drive mechanism, put in place all the structural modifications relating to safety measures and to the protection or segregation of all the zones involving hazards of crushing, shearing, entrapment and of general hazard. Check that all the existing structure has the necessary requirements of strength and stability. The manufacturer of the drive mechanism is not responsible for failing to conform to good practice in the construction of the windows to be opened, as well as any distortion which could occur during use.

Put up the notices laid down by current regulations to identify hazardous areas.

Ensure that the electrical supply is not a temporary one, but has the required electrical boxes, and in case of doubt or lack of (definite) information, also install:

- suitable isolating transformers
- thermal magnetic cut-outs suitable to voltage requirements
- surge arrester.

Before connecting the electrical supply, ensure that the electrical rating correspond to that of electrical distribution supply. Fit onto the supply network an allpole switch with a contact gap of at least 3 mm. Check

that on the supply side of the electrical plant there is a suitable differential residual current circuit breaker and overload protection.

When required to do so, connect to an efficient earthing/ground system fitted according to the safety regulations in force in the country where the actuator is being installed. Before carrying out any operation (installation, maintenance or repair), isolate the electrical supply before working on the equipment. To ensure complete isolation from the supply current, installation is recommended of a double-pole switch of the approved type. The low-voltage 24 V dc actuators must be supplied by suitable power supplies (NOT TRANSFORMERS) of an approved Class II type [double safety insulation] having an output voltage of 24V dc -15% to +20% (or from 20.4V dc min. to 28.8V dc max.) When using the 24V dc version, the cable must have a suitable cross-section, calculated based on the distance between the power supply and the actuator, so as not to have a voltage drop or loss.

Cross section of cables	Max length of the cable
1,50 mm <sup>2</sup>	~ 100 m
0,75 mm <sup>2</sup>	~ 50 m

The device is not intended to be used by people (including children) whose physical, sensory or mental capabilities are reduced or by people who lack in experience or knowledge, unless a person responsible for their safety can control them or give them instructions concerning the use of the device. Children must be supervised to ensure that they do not play with the device.

The Raywin spindle actuator is intended only and exclusively for use for which it was designed, and the manufacturer cannot be held responsible for damage due to its improper use. The actuator is intended exclusively for internal installation to open top-hung and bottom-hung windows, skylights, dormer windows and roof windows. Any other use is not recommended unless with the prior approval of the manufacturer. Install the actuator according to the instructions shown in this manual.

Any apparatus serving and controlling the actuator must be produced according to the regulations in force and respect the relevant standards issued by the European Community.

If the actuator is installed on a window at a height of less than 2.5 m from the floor and in buildings (public and otherwise) in which the use of destination is not clear, it must be operated exclusively by a command which is not accessible by public (key button).

The command button has to:

- 1) be placed at a height of 1500 mm from the floor
- 2) be positioned so that, at its activation, a person who carries the opening and closing has within its field of view all the moving parts.

Do not wash the apparatus with solvents or jets of water. Do not immerse the apparatus in water.

Any repair must be carried out by qualified personnel (the manufacturer or an authorised service centre).

Always insist that only original spare parts are used.

Failure to use the original spare parts could compromise the correct operation of the product and the safety of people or property, also annulling the effects of the guarantee enclosed with the apparatus.

In case of any problems or doubt, contact the point of sale where the product was purchased or the manufacturer directly.

# 3. TECHNICAL DATA

## 3.1 Table of technical data and mark

The CE mark certifies that the actuator conforms to the essential health and safety requirements laid down by European product directives. The CE mark can be identified by the relevant adhesive label applied to the outside of the product, on which are shown some of the data shown in the following table:

	Raywin	Raywin 2W-Net Raywin 3W-Net Raywin 4W-Net	Raywin	Raywin 2W-Net Raywin 3W-Net Raywin 4W-Net
Model R60	MR60S1yH0G00*	MR60SxyH0G00**	MR60S1yL0G00*	MR60SxyL0G00**
Model R45	MR45S1yH0G00*	-	MR45S1yL0G00*	-
Model R20	MR20S130H0G00	-	MR20S130L0G00	-
Electrical power supply	110-230Vac	110-230Vac	24Vdc	24Vdc
Frequency	50-60Hz	50-60Hz	-	-
Operation	S2 4 min.			
Thrust/traction force R60	600 N	600 N	600 N	600 N
Thrust/traction force R45	450 N	450 N	450 N	450 N
Thrust/traction force R20	200 N	200 N	200 N	200 N
Stroke speed unloaded	7 mm/s			
Protection class	IP44			
Double insulation	Yes		Low voltage	
Rated Current / Power R60	0,33A / 41W	0,33A / 41W	1,7A / 41W	1,7A / 41W
Rated Current / Power R45	0,23A / 29W	-	1,2A / 41W	-
Rated Current / Power R20	0,13A / 17W	-	0,7A / 41W	-
Operating temperature	-5° / +50°			
Strokes R60	180 / 225 / 300 – 500			
Strokes R45	70 / 160 / 200 – 235 / 300 – 400			
Strokes R20	105 / 180 / 300			
Open limit switch	on impact			
Closed limit switch	on impact			
Soft Start/Soft Stop	yes / yes	yes / yes	yes / yes	yes / yes
Obstacle detection	yes	yes	yes	yes
Connection in parallel	yes   max 30 actuators			
Synchronisation	no	yes	no	yes
Dimensions	400/600x84x48			
Weight	Variable according to stroke			

\* / \*\* Replace "y" with stroke value for R60: 30 (180/225/300 mm), 50 (500mm) R45: 20 (70/160/200) 30 (235/300 mm), 40 (400mm)  
Replace "x" with synchronisation value: 2 = two actuators, 3 = three actuators, 4 = four actuators.

## 4. ACTUATOR

### 4.1 Types of power supply

The Raywin series of actuators is available in various models and in two electrical supply versions:

- 230Vac can be supplied with mains power ranging between 110 and 230 V ac (50/60Hz) (with a tolerance of  $\pm 10\%$ ), with a three-core supply cable: BLUE, neutral common; BLACK, open phase; BROWN, closed phase.
- 24Vdc can be supplied with a voltage of 24V dc with a two-core supply cable: BLUE, connected to the + (positive) closed; BROWN, connected to the + (positive) open.

### 4.2 Calculation of the force necessary

- Simbologia**
- P = Force required to open in kg (kilogrammes)
  - P = Weight of the window (only moveable part) in kg (kilogrammes)
  - C = Opening travel of actuator in cm. (centimetres)
  - H = Height of the openable part of the window in cm. (centimetres)

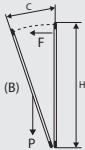
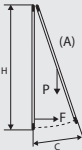
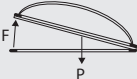
Bottom-hung inward opening	Top-hung outward opening	Horizontal skylight
		
$F = [P / 2] \times [C/H]$	$F = [P / 2] \times [C/H]$	$F = P / 2$

### 4.3 Pack and tools required for assembling the actuator

The actuator is packed individually in a cardboard box. Each pack contains:

Electric actuator, 110-230V – 50/60Hz or 24Vdc, with electric supply cable, support brackets, fixing bracket for top-hung window, fixing bracket for bottom-hung window and instruction manual.

Before starting to fit the actuator, we recommend preparing the following fitting materials, tools and equipment: Metre rule or tape measure, pencil, drill/screwdriver, set of drill bits for metal or wood, set of screw bits, electrical pliers, screwdrivers, screws and/or threaded inserts suitable for the type of window material. **AVOID** using self-tapping screws and/or three-lobed screws on any metal windows.



**Top-hung outward opening window**

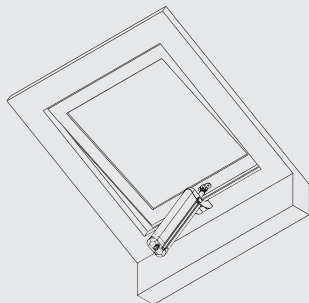

**Solar shading type**

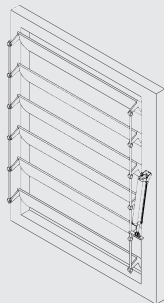

**CAUTION** If the window is of the bottom-hung type, check that the limiting arms have been fitted to prevent the window from accidentally falling down.

**Top-hung outward opening window:**

With a pencil, mark the mid-point "X" of the window frame.

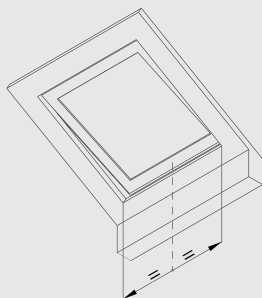

**Solar shading:** Mark with a pencil the position of the 3 holes for fixing the support bracket.

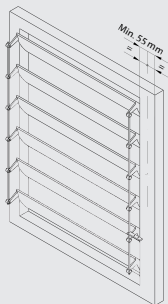



**Top-hung outward opening window:  
Accessories to be used**

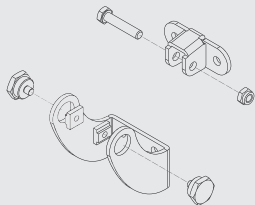

**Solar shading: Accessories to be used**

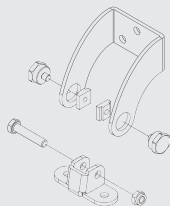

Drill holes in the frame using the measurements shown on Page 6.  
Fix the brackets and the fixings, using suitable screws.

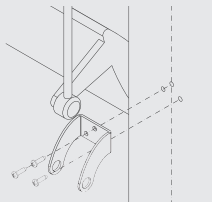
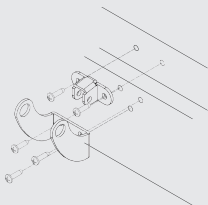
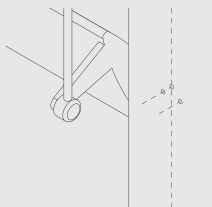
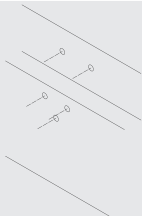

### Top-hung outward opening window

### Solar shading

Insert the fixing screws in the corresponding holes in the support bracket.

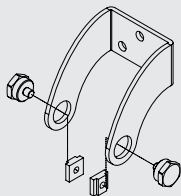
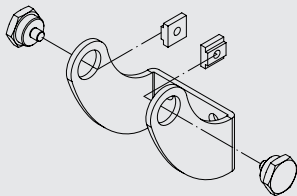

Screw the bolts, without tightening them, into the "T"-shaped plates.

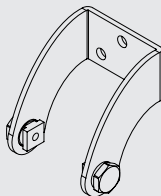
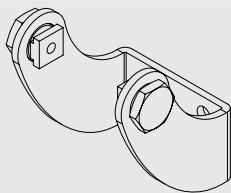

Insert the actuator into the plates just screwed in. Do not tighten the bolts up into the plates completely.

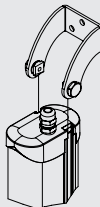
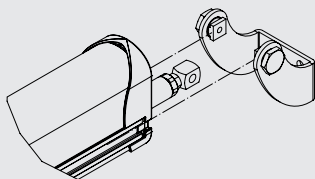

### Top-hung outward opening window

### Solar shading

Move the actuator near to the fixing by sliding it on the plates so that the hole in the tracking strip (screwed to the spindle) matches up with the lateral hole on the fixing.

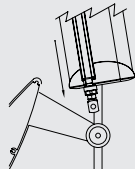
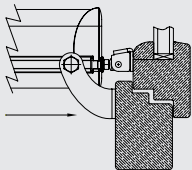

Fix the spindle to the fixing by using the relevant nut and bolt supplied. Tighten the bolts completely to the plates.

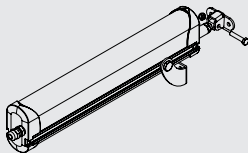

Top-hung outward opening window / Solar shading: Setting the travel. Make the spindle come out by about 10 cm, by connecting the actuator to the electric supply. Remove the front plastic cover, and then, using a cross-headed screwdriver, also remove the rubber cap.

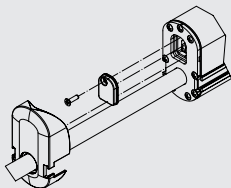

Top-hung outward opening window / Solar shading: Positioning the DIP-switches

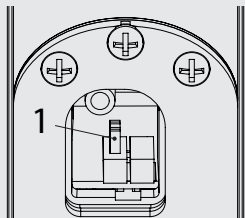

Select the stroke required (Raywin 600N has 3 strokes, 450N has 2+3 strokes, and 200N has 3 strokes), by following the setting of the DIP-switches according to the scheme below Note: each DIP-switch has three possible positions.

Raywin 600N	Dip-switch 1	Raywin 450N	Dip-switch 1	Raywin 200N	Dip-switch 1	
Stroke 300	Pos. 1	Stroke 300	Pos. 1	Stroke 300	Pos. 1	
	Pos. 2		Pos. 2		Pos. 2	
	Pos. 3		Pos. 3		Pos. 3	
Stroke 225	Pos. 1	Stroke 235	Pos. 1	Stroke 180	Pos. 1	
	Pos. 2		Pos. 2		Pos. 2	
	Pos. 3		Pos. 3		Pos. 3	
Stroke 180	Pos. 1	<b>Raywin 450N</b>	<b>Dip-switch 1</b>	Stroke 105	Pos. 1	
	Pos. 2				Pos. 1	Pos. 1
	Pos. 3				Pos. 2	Pos. 2
		Stroke 200	Pos. 1		Pos. 3	
			Pos. 2		Pos. 1	
			Pos. 3		Pos. 2	
		Stroke 160	Pos. 1		Pos. 3	
			Pos. 2		Pos. 1	
			Pos. 3		Pos. 2	
		Stroke 70	Pos. 1		Pos. 3	
			Pos. 2		Pos. 1	
			Pos. 3		Pos. 2	

## 5.2 Electrical connection

Wire in the apparatus according to the electrical supply required by the actuator (see label on product), following the table below.

230Vac supply			24Vdc supply		
0	Yellow/Green	Earth	1	Blue	Positive
1	Blue or Gray	Neutral / Common	2	Brown	Negative
2	Black	Phase / Open	4	White	Data [2/3/4 W-Net actuators]
3	Brown	Phase /Closed	5	Yellow	Data [2/3/4 W-Net actuators]
4	White	Data [2/3/4 W-Net actuators]	6	Green	Data [2/3/4 W-Net actuators]
5	Yellow	Data [2/3/4 W-Net actuators]			
6	Green	Data [2/3/4 W-Net actuators]			

**Electric 230Vac wiring**

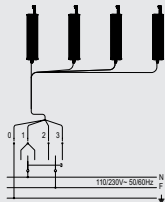

**Electric 24V dc wiring**

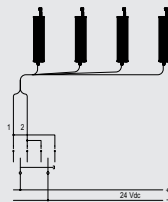

**Electric 230Vac wiring  
[2/3/4 W-Net actuators]**

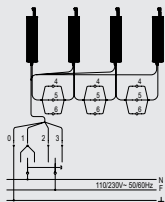

**Electric 24V dc wiring  
[2/3/4 W-Net actuators]**

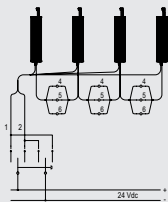

### 5.3 Operating test

Press the control button and close the window, checking that:

- a. The window is completely closed. If it is not, check that the gap between the window and the frame is bigger than or equal to 0 mm. If necessary, insert spacers so as to obtain the correct gap.
- b. The spindle is perfectly perpendicular to the window frame. If necessary adjust the fixing bracket by using the screws and slots.

Having reached the correct closing position, press the control button and open the window in order to check that the actuator runs freely over the full travel set up.

Having achieved the required opening run, press the control button again to close the window. Once the window has completely closed, check that the screws, supports and fixings are tightened correctly, and that the seals are sufficiently compressed.

#### **Top-hung outward opening window / Solar shading: Closing the DIP-switch compartment.**

Replace the rubber cap and screw up the retaining screw. Replace the plastic cover so that it cannot come out of place. By connecting the actuator to the electrical supply, make the spindle go back into the position required.

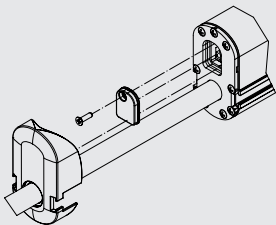

Installation completed

## 6. MAINTENANCE, EMERGENCY ACTION & CLEANING

If it becomes necessary to manually disconnect the window from the actuator due to: a power failure, mechanical breakdown, maintenance, or cleaning the exterior of the window, follow the step sequence described on Page 11 in reverse order.

**BEWARE OF THE DANGER** of the window falling; as the window is free to fall, as it is no longer held up by the spindle.

Once the maintenance or cleaning operations have been completed, repeat the sequence described on Page 11.

## 7. PROTECTION OF THE ENVIRONMENT

Some parts inside the actuator are not recyclable (plastic materials and electronic parts) and cannot be considered normal refuse. They must be disposed of correctly. In case of doubt, consult the relevant refuse disposal body.

## 8. FAQ (frequently asked questions)

Question	Cause	Remedy
The actuator is not operating	No voltage supply	<p>Check the electrical cut-out or safety switch is "On".</p> <p>A cable may not be connected. Check the actuator voltage corresponds to voltage supply detected.</p>
	With voltage supplied	Check the actuator voltage corresponds to voltage supply detected.
The actuator is not travelling the distance required	The window opening is not as required	Check that according to the table on Page 12 the DIP-switches are set for the correct travel.
		Detach the spindle from the fixing and check that the limiting arm allows the actuator to travel the complete run. If this does not happen, adjust the limiting arm so that the actuator travels the whole distance.
The actuator pulls out the screws	Fixing is no longer fastened to the frame	Check that suitable fixings have been used.
		Check that, on closing, the spindle is perfectly perpendicular to the frame. If not, check that the fitting was carried out according to the Installation Sequence, 5.1.



## 9. GUARANTEE

The manufacturer guarantees the correct operation of the actuator.

The manufacturer undertakes to replace parts which are faulty due to manufacturing faults or defects, according to that laid down by Article 1490 of the Italian Civil Code. The guarantee covers the products or individual parts for a period of 36 months from date of purchase.

This is valid if the purchaser is able to show the purchase receipt and has satisfied the agreed conditions of payment.

The guarantee of correct operation of the actuators issued by the manufacturer means that the manufacturer undertakes to repair or replace free of charge, in the shortest time possible, those parts that have become faulty due to defects in construction or material defects during the period of the guarantee.

The purchaser cannot claim the right to any compensation for any damages, direct or indirect, or to other costs.

The guarantee does not cover parts which are fragile or exposed to wear and tear, or to corrosive process agents, or to overloading, even if only temporary, etc.

The manufacturer cannot be held responsible for any damage caused by incorrect assembly, fitting or movement, by excessive stress or unskilled or incorrect use. For this reason, we recommend maintenance be carried out every 6 months.

The manufacturer cannot be held responsible for the guarantee if the product has been mishandled, disassembled, had its label removed, or exhibits evidence of impact or other factors.

**EC DECLARATION OF INCORPORATION FOR PARTLY COMPLETED MACHINERY**

**(Directive 2006/42/EC, Annex II-B)**

The manufacturer **Fratelli Comunello S.p.A.**, headquarters in **Via Cassola 64, I-36027, Rosà (VI), Italy**.

Under its sole responsibility hereby declares that:

the partly completed machinery model(s):

- RAYWIN R60 230VAC, RAYWIN R60 2W-Net 230VAC, RAYWIN R60 3W-Net 230VAC, RAYWIN R60 4W-Net 230VAC
- RAYWIN R60 24VDC, RAYWIN R60 2W-Net 24VDC, RAYWIN R60 3W-Net 24VDC, RAYWIN R60 4W-Net 24VDC
- RAYWIN R45 230VAC, RAYWIN R45 24VDC
- RAYWIN R20 230VAC, RAYWIN R20 24VDC

Identification number and year of manufacturing: **typed on nameplate**

Description: **electromechanical actuator for windows, domes, skylights and sun shading**

- is intended to be installed on window/dome/skylight/sun shading to create a machine according to the provisions of the Directive 2006/42/EC. The machinery must not be put into service until the final machinery into which it has to be incorporated has been declared in conformity with the provisions of the Directive 2006/42/EC (annex II-A).
- is compliant with the applicable essential safety requirements of the following Directives:  
Machinery Directive 2006/42/EC (annex I, chapter 1)  
Low Voltage Directive 2006/95/EC.  
Electromagnetic Compatibility Directive 2004/108/EC.

This partly completed machinery complies with the following Essential Requirement of 2006/42/CEE directive:

1.1.3 – 1.1.5 – 1.3.4 – 1.3.7 – 1.3.9 – 1.5.1 – 1.5.2 – 1.5.5 – 1.5.6 – 1.5.8 – 1.5.10 – 1.5.11 – 1.5.16 – 1.6.1 – 1.7.1

**During the development of this machinery the following harmonised standards have been applied:**

EN 55014-1(2006-12) - A1(2009-08);  
EN 55014-2(1997) - A1(2001) – A2 (2008) – IS1(2007);  
EN 61000-3-2 (2006); EN 61000-3-3 (2008-09);  
EN 61000-6-2 (2005); EN 61000-6-3 (2007);  
EN 60335-1 (2002) – A1 (2004) - A2(2006); EN 60335- A11 (2004) – A12 (2006) – A13(2008);  
EN 62233 (2008-04);

The relevant technical documentation is available at the national authorities' request after justifiable request to:

**Fratelli Comunello S.p.A., Via Cassola 64,  
I-36027, Rosà (VI), Italia.**

The person empowered to draw up the declaration and to provide the technical documentation:

Luca Comunello  
Legal representative of Comunello S.p.A.  
Rosà, 10th January 2011







# Notes

---

---

---

---

---

---

---

---

---

---





# RAYWIN

code: 91300104 / VS. 00 / Print 02-2011

 **Comunello**<sup>®</sup>

Fratelli Comunello S.p.A.,  
Via Cassola, 64 - 36027 Rosà (Vicenza), Italy.  
Tel. +39-0424.585.111 - Fax +39-0424.533417

[www.comunello.com/mowin](http://www.comunello.com/mowin)